

Optical Microscopy Course
EDU-OMC1
EDU-OMC1/M

User Guide

















Table of Contents

Chapter 1	Warning Symbol Definitions	1
Chapter 2	Safety	2
Chapter 3	Brief Description	3
	3.1 Introduction	3
	3.2 Setup Overview	5
	3.3 Lab Notes and Course Notes Overview.....	7
	3.4 Supplementary Documentation	9
	3.5 Getting started.....	9
Chapter 4	Kit Components	10
Chapter 5	Setup and Adjustment.....	21
	5.1 Breadboard and Rail Assembly.....	21
	5.2 Optics Subassemblies	22
	5.2.1 Halogen Lamp Assembly	23
	5.2.2 Collector Lens Assembly	25
	5.2.3 Field Stop	26
	5.2.4 Filter Wheel Assembly	26
	5.2.5 Flip Mount Assembly	27
	5.2.6 Condenser Assembly	29
	5.2.7 Sample Stage Assembly	30
	5.2.8 PCX Objective Assembly	32
	5.2.9 Achromatic Objective Assembly	32
	5.2.10 Back Focal Plane (BFP) Beamsplitter Assembly	34
	5.2.11 Microscope Objective (Nikon)	35
	5.2.12 Filter Holder Assembly	35
	5.2.13 Polarization Mount Assembly	35
	5.2.14 Fluorescence Filter Assembly	37
	5.2.15 Diffuser Assembly	37
	5.2.16 LED and Multi-Purpose Mount Assembly	37
	5.2.17 Sample Camera Assembly	39
	5.2.18 Back Focal Plane (BFP) Camera Assembly	41
	5.2.19 780 nm Longpass Assembly	42
	5.2.20 Multi-Purpose Mount Assembly	43
	5.2.21 Optical Fiber Mount	43
	5.2.22 Zero Order Blocking Mask	44
	5.3 Thin Slip-On Post Collars.....	45
	5.4 Strain Relief.....	45
	5.5 Overhead Lamp and LED Flashlight.....	46
	5.6 Plastic Bin and Spare Parts	47
Chapter 6	Samples	48
Chapter 7	Software Installation and Digital Materials	50
	7.1 Software Installation.....	50
	7.1.1 ThorCam Camera Software	50
	7.1.2 Thorlabs OSA Spectrometer Software	50
	7.1.3 Additional Software	51
	7.2 Supplied Digital Materials	51
Chapter 8	Regulatory	52
Chapter 9	Thorlabs Worldwide Contacts.....	53

Chapter 1 Warning Symbol Definitions

Below is a list of warning symbols you may encounter in this manual or on your device.

Symbol	Description
	Direct Current
	Alternating Current
	Both Direct and Alternating Current
	Earth Ground Terminal
	Protective Conductor Terminal
	Frame or Chassis Terminal
	Equipotentiality
	On (Supply)
	Off (Supply)
	In Position of a Bi-Stable Push Control
	Out Position of a Bi-Stable Push Control
	Caution: Risk of Electric Shock
	Caution: Hot Surface
	Caution: Risk of Danger
	Warning: Laser Radiation

Chapter 2 Safety



CAUTION



After the QTH10 lamp warms up, the housing will reach a temperature of up to 55 °C. Be careful not to touch the lamp housing during operation.



CAUTION



The kit includes an IR LED (LED1550E), which does not emit in the visible range. The LED emission can be checked with most cameras (camera chips are often IR sensitive). Do not look into IR LEDs in general for a prolonged time.

Chapter 3 Brief Description

3.1 Introduction

This experimental setup is a teaching-oriented kit covering the content of a whole quarter- or semester-long optics and microscopy course. It is structured in 10 units, each covering a different topic. Each unit is accompanied by extensive teaching materials: The *Course Notes* cover theory, the *Lab Notes* cover lab procedures, and the *Instructor Notes* include tips for running the course. Additional video content is provided online on the product website www.thorlabs.com/OMC. During the course, students build working light microscopes using optomechanical parts, then use them to investigate imaging and contrast methods (including darkfield and phase contrast, as well as fluorescence), theory (including aberrations, the Abbe theory of image formation, and fluorescence filter use), and proper microscope set-ups (including Kohler illumination and camera use).

This *User Guide* provides a starting point for working with this kit. An overview of the documentation for this course is provided in Section 3.2, followed by the component assembly in Chapter 5. This lab course and materials were developed by Neil Switz and Daniel Fletcher at the University of California, Berkeley, and have been used in the teaching curriculum there for many years. They have been substantially updated and revised as part of a multiyear collaboration with Thorlabs in order to make the material more widely available; in the process, substantial new hardware has been developed to improve and/or simplify offering of the material.



Figure 1 Overview of the optical microscopy setup. The kit contains an open rail with all optical components to go through the teaching steps. Furthermore the kit contains a research grade spectrometer, various samples and tools to experiment, learn and evaluate.



Figure 2 Overview of the included documentation. A total amount of about 500 pages gives the physical background, step-by-step instructions of the assembly and lab procedure, as well as tips for tutoring the course.

The *Course Notes* cover the theory for each lab's material. The *Lab Notes* provide instructions and tasks for the students (intended for 3-hour lab sections) and provide the basis for each lab report. The *Instructor Notes* are for instructors and teaching assistants overseeing the lab sections and include suggestions for pre lab quizzes and tips for supporting the labs. Note: These notes are not intended to replace lectures or to provide complete documentation for those lectures. The suggested workflow of using this kit is shown in Figure 3.

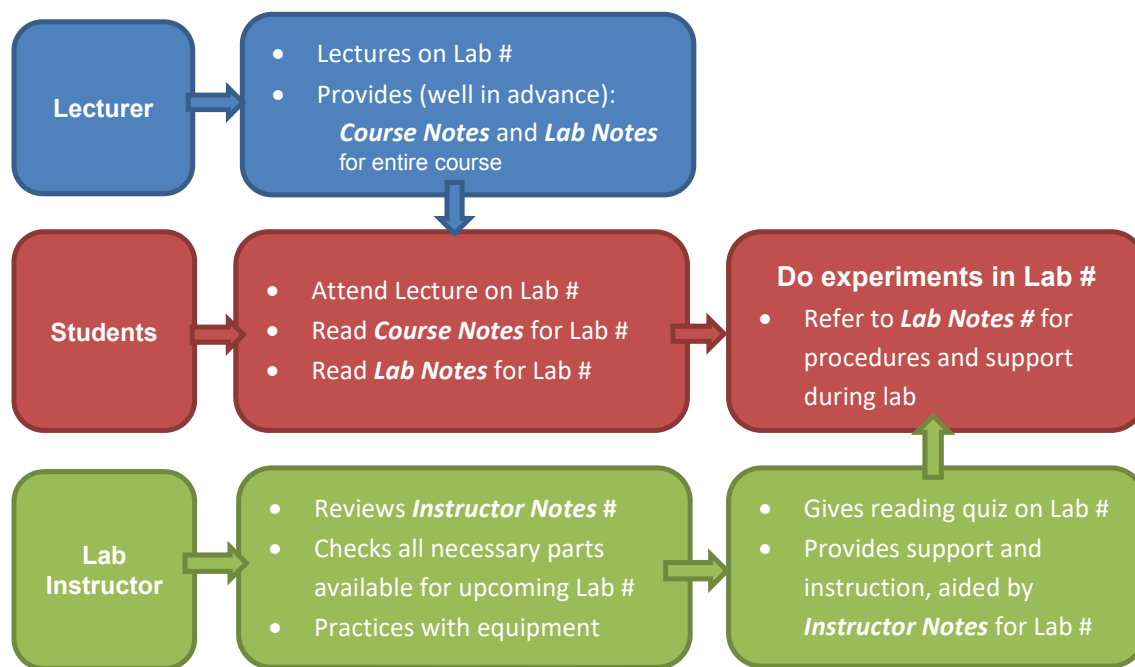

Figure 3 Graphical representation of the workflow during a lecture week and distribution of the documentation. The # stands for one of the 10 labs provided.

This kit is intended for use in a course-based teaching environment, and may be difficult to use outside of one because of the in-depth teaching materials fitted to this concept. The kit targets optics faculty who want to expand their teaching beyond theoretical explanations; in the United States this material would typically underlie a quarter- or semester-long lab class, at the upper-division level. The benefit of this kit is an all-in-one solution with tested samples and supporting materials covering most important aspects of microscopy and optical imaging. Students will usually work on one rail setup in small groups, with preferably not more than two students per setup. Additionally, a lab instructor should be available to support students during the lab work.

The documentation is *not* intended to be cook-book; questions for students are regularly raised without answers necessarily being provided, and students are led to figure out for themselves how to accomplish various tasks. Images in the documentation are purposefully limited in order to get students to think for themselves about their results rather than merely replicating steps in a lab manual. During this course, students build their knowledge in a systematic manner – the lab material is carefully sequenced – providing the opportunity both to learn and then to apply that new knowledge in a hands-on manner. The intent is to provide students with skills that enable them to confidently develop their own applications of imaging and microscopy for future projects and work.

3.2 Setup Overview

The central focus of the kit is to learn how to set up an optical microscope and explore different microscope properties and configurations.

Starting in Labs 1 and 2, the students learn how to handle the optical rail system and lenses, and how to set up camera imaging in an infinity-corrected system. Acquiring their first images using the rail system concludes the first two labs.

In Labs 3 and 4, students learn about optical resolution, illumination coherence, and chromatic aberrations by manipulating the numerical aperture of their objective, adjusting their light source, and using a diffusor. At the end of Lab 4, students will have their microscope in the most commonly used configuration, set up for Kohler illumination as shown in Figure 4. *Figure 4 Overview of the components on the optical rail: .*

In Labs 5 and 6, students explore manipulation of image information in the objective back focal plane, and different imaging and contrast methods (e.g. darkfield) are introduced. Students explore the Abbe theory of image formation, and learn how image formation results from interference of diffracted beams, as shown in Figure 4 and Figure 5.

Labs 7 and 8 delve further into resolution and contrast, introducing the Modulation Transfer Function (MTF). Students also learn about – and set up themselves – phase contrast, and explore its imaging properties.

In Labs 9 and 10, fluorescence microscopy is introduced and students set it up on the rail using excitation and emission filters. There is an extensive problem set / worked exercise, where students optimize filter selection for a given fluorophore and illumination source.

Each experiment includes multiple evaluation tasks for students to perform, giving them experience with both qualitative observation and quantitative comparison of data with theory.

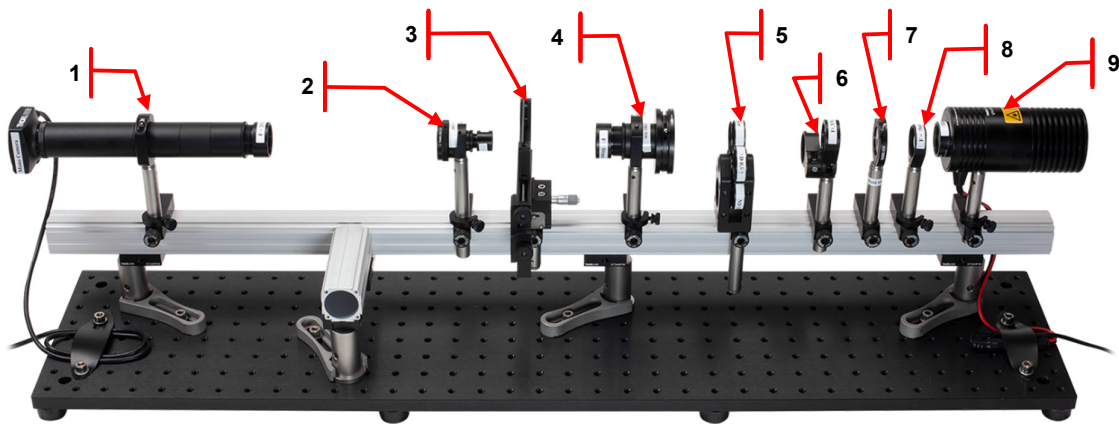

Figure 4 Overview of the components on the optical rail: 1) Camera, 2) Objective, 3) Sample, 4) Condenser and Aperture Stop, 5) Neutral Density Filter Wheel, 6) Green Filter, 7) Field Stop, 8) Collector Lens, and 9) Lamp with IR Filter

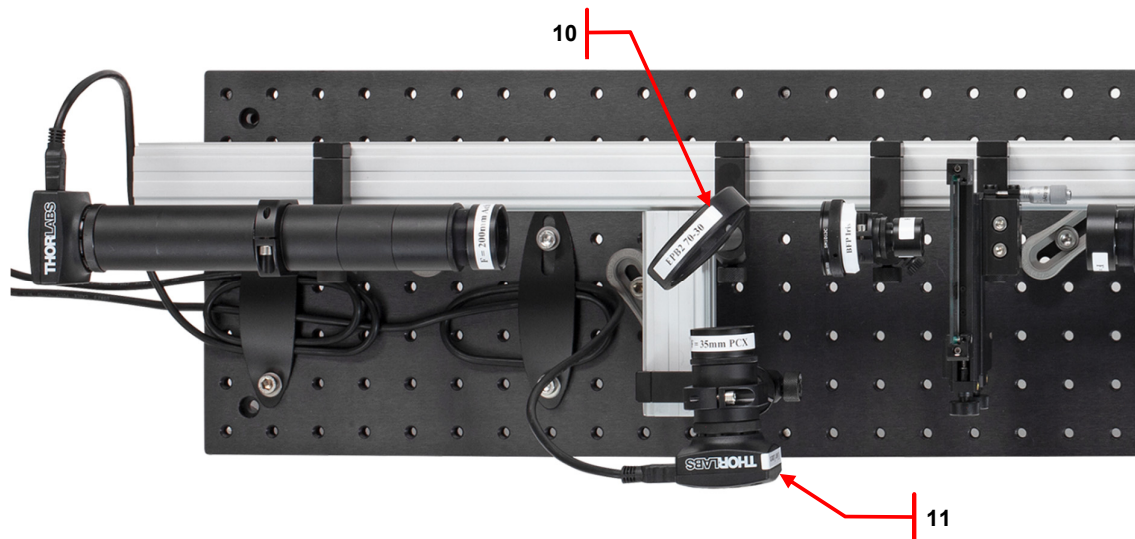



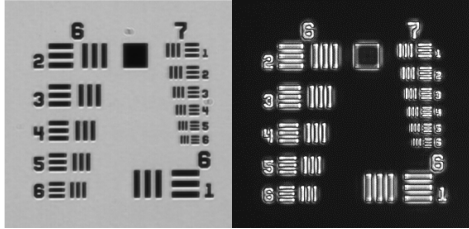
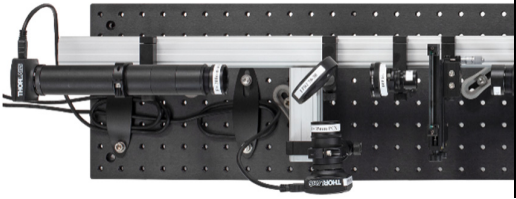
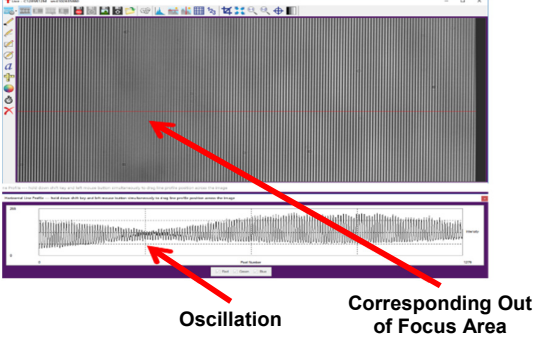

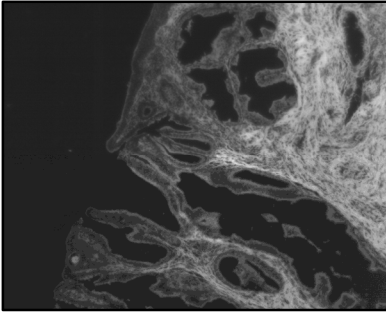
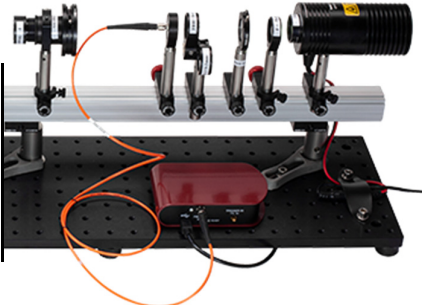

Figure 5 Photo of a second camera imaging the back focal plane of the objective to teach image formation: 10) Beamsplitter and 11) Back Focal Plane Camera.

3.3 Lab Notes and Course Notes Overview

This section provides a quick run through of the content of each lab with graphical illustrations of the key features.

Lab	Lab Content	
1	 <p>The image shows a black Thorlabs camera on the left and a red Thorlabs camera control unit on the right. Below them is a screenshot of the Thorlabs software interface, which displays a graph of intensity versus wavelength.</p>	<p>Introduction to Optical Imaging (I)</p> <ul style="list-style-type: none"> - Handling Cameras and Using Camera Software Controls - Imaging and Lenses; Lens Focal Length - Cameras (Color and Monochrome) - Light Spectra
2	 <p>The image shows a black microscope on the right and a small inset image of a suspension bridge on the left.</p>	<p>Introduction to Optical Imaging (II)</p> <ul style="list-style-type: none"> - Imaging with a Camera and Focusing at Infinity - Setting Up the Rail System - Imaging and Resolution Measurement
3	 <p>The image shows an optical bench setup with various lenses and components mounted on a rail.</p>	<p>Aberrations and Illumination</p> <ul style="list-style-type: none"> - Lens Orientation - Illumination Spatial Coherence - Color (Chromatic Aberration); Achromatic Lenses
4	 <p>The image shows an optical bench setup similar to Lab 3, but with more complex components and a different arrangement.</p>	<p>Köhler Illumination</p> <ul style="list-style-type: none"> - Collection Optics - Condensing Optics - Köhler Illumination - Numerical Aperture (NA) <ul style="list-style-type: none"> o Resolution o Image Brightness
5	 <p>The image shows two sets of resolution test charts. The left set is a brightfield image, and the right set is a darkfield image. Both sets show patterns of lines and dots of varying sizes and orientations.</p> <p>Example of a Brightfield and Darkfield Image</p>	<p>Köhler, Conjugate Planes, and Darkfield Imaging</p> <ul style="list-style-type: none"> - Point-Spread Function (PSF) - Darkfield and Oblique Illumination - Image Manipulation in the Objective Back Focal Plane (BFP): <ul style="list-style-type: none"> o Darkfield I: Image Subtraction o Convolution and the PSF o Darkfield II: Convolution and Subtraction

<p>6</p>		<p>The Abbe Theory of Image Formation (I)</p> <ul style="list-style-type: none"> - Imaging the BFP: Setting Up a BFP-Imaging Camera - Diffraction and the BFP - Spatial Filtering in the BFP
<p>7</p>	 <p style="text-align: center;">Oscillation Corresponding Out of Focus Area</p>	<p>The Abbe Theory of Image Formation (II)</p> <ul style="list-style-type: none"> - The Modulation Transfer Function (MTF) <ul style="list-style-type: none"> o Incoherent MTF o Coherent MTF - The Edge-Spread Function (ESF) and the MTF
<p>8</p>		<p>Contrast Methods and Abbe Theory</p> <ul style="list-style-type: none"> - Brightfield - Darkfield and Signal-to-Background - MTF and Contrast - Phase Contrast
<p>9</p>		<p>Fluorescence Microscopy</p> <ul style="list-style-type: none"> - Fluorescence and Fluorescence Imaging on the Following Samples: <ul style="list-style-type: none"> o Autofluorescent Slides o Lens Tissue with Fluorescent Markers o H&E (Fluorescent Eosin) Stained Tissue Samples
<p>10</p>		<p>Spectra and Filters</p> <ul style="list-style-type: none"> - Light Spectra - Filter Transmission and Behavior - Spreadsheet-Based Problem Set on Quantitative Filter Selection

3.4 Supplementary Documentation

This kit references various additional resources (beyond those in the course documentation) useful for teaching aspects of microscopy, including videos, webpages, and scientific literature. All webpages referenced in the notes have a link to the kit's product page, which has a central references tab with the current web links. Particular emphasis is placed on video material, specifically a beautiful microscopy tutorial by Dr. Peter Evennett that covers the Abbe theory of image formation, as well as extended video material for working with optomechanical hardware. A USB stick is also provided with the kit and includes all documentation (Course Notes, Lab Notes, and Instructor Notes), as well as the Evennett Abbe videos and assembly videos. Secondary references to the optics literature include some papers, which may require access to technical journals either via a typical university library or subscription.

3.5 Getting started

Chapter 4 of this document shows all parts included in the kit. The following chapter, Chapter 5, provides instructions on assembling the optical components. After assembly of the optics, you should prepare the computer(s) and install the camera and spectrometer software. You will find helpful information in the Appendices of the Lab Notes, Course Notes, and (particularly) the Instructor Notes. The primary course instructor should go through all labs with the lab instructor(s) and schedule the weeks for the different labs. Unless this is the first offering of the course, be sure to check that consumable materials like gloves, cover slides and lens tissues have been replenished. Consumables can also be found on the Thorlabs web page¹.

After setting up the rail and assembly of the components, you can read the Course Notes and (especially) the Lab Notes and plan how you wish to use the materials / approach the course. The Instructor Notes are particularly helpful for refreshing your memory of labs from year-to-year, and for helping prepare teaching staff. For instructors, especially those using the materials for the first time, we strongly recommend using the *Assembly*, *Kohler*, and *Back Focal Plane* videos at the www.thorlabs.com/OMC video tab both for a quick rundown of the assembly steps and to assist in setting up the system for the first time. Be aware that using these videos will skip most of the learning experience; we recommend that students approach the course via the Lab Notes and working it out themselves, in class, instead.

¹ Optics Lab Supplies: https://www.thorlabs.de/navigation.cfm?guide_id=2007





Chapter 4 Kit Components

All kit components are shown below, broken out by subassembly for convenience as you set up. Unless otherwise noted, in cases where the metric and imperial kits contain parts with different item numbers, metric part numbers and measurements are indicated by parentheses.

Rail System

 <p>1 x Aluminum Breadboard 8" x 36" x 1/2" (20 cm x 90 cm x 1.27 cm), Single Density Taps</p>	 <p>2 x RDF1 Rubber Damping Feet, Set of 4</p>	 <p>1 x XT34-100 1 x XT34-900 34 mm Construction Rails, 100 mm and 900 mm Long</p>
 <p>4 x RS2P (RS2P/M) Ø1" Pedestal Post, 1/4"-20 (M6) Taps, 2" Long</p>	 <p>4 x CF175C (CF175C/M) Clamping Fork, 1.76" (44.8 mm), 1/4"-20 (M6) Captive Screw</p>	 <p>6 x XT34HP (XT34HP/M) Dovetail Mounting Clamp for 34 mm Rails</p>
 <p>12 x XT34TR1 (XT34TR1/M) 1/2" (12.5 mm) Rail Carrier</p>	 <p>1 x XT34TR2 (XT34TR2/M) 1" (25 mm) Rail Carrier</p>	 <p>1 x Right Angle Rail Adapter for XT34HP (XT34HP/M) Dovetail Mounting Clamp</p>

General Tools and Optomechanics

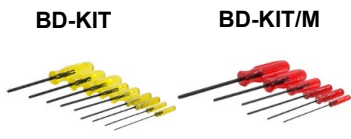
 <p>1 x CCS200 (CCS200/M) Compact Spectrometer, 200 nm - 1000 nm, Software and Fiber Patch Cable Included</p>		 <p>2 x R2T Thin Slip-On Post Collar for Ø1/2" Posts, 5 Pack (10 Post Collars Total)</p>
 <p>1 x TR2 (TR50/M) Ø1/2" (Ø12.7 mm) Optical Post, Stainless Steel, 2" (50 mm) Long</p>	 <p>16 x TR3 (TR75/M) Ø1/2" (Ø12.7 mm) Optical Post, Stainless Steel, 3" (75 mm) Long</p>	 <p>6 x TR4 (TR100/M) Ø1/2" (Ø12.7 mm) Optical Post, Stainless Steel, 4" (100 mm) Long</p>
 <p>1 x LA1765 Ø30.0 mm N-BK7 Plano-Convex Lens, f = 75.0 mm, Uncoated</p>	 <p>1 x LA1031 Ø30.0 mm N-BK7 Plano-Convex Lens, f = 100 mm, Uncoated</p>	 <p>1 x MC-5 Lens Tissues, 25 Sheets per Booklet, 5 Booklets</p>
 <p>1 x SPW602 SM1 Spanner Wrench, Graduated, Length = 3.88"</p>	 <p>1 x SPW603 SM05 Spanner Wrench, Length = 1"</p>	 <p>BD-KIT BD-KIT/M</p> <p>1 x BD-KIT (BD-KIT/M) Balldriver Kit</p>

 <p>1 x HKTS-3/16 (HKTS-5M) 3/16" (5 mm) Hex Key Thumbscrews, Pack of 4</p>	 <p>1 x MS10UW2 Microscope Slides, 1 mm Thick, White Marking Region, Pack of 200</p>	 <p>1 x CG00C2 Cover Glasses, #0 Thickness, 22 x 22 mm, Pack of 200</p>
 <p>1 x SM1EC2B Snap-On Plastic Dust Cap for SM1 Lens Tubes, 5 Pack</p>	 <p>4 x SM1RC (SM1RC/M) Slip Ring for SM1 Lens Tubes</p>	 <p>5 x LMR1 (LMR1/M) Lens Mount with Retaining Ring for Ø1" Optics 8-32 (M4) Tap</p>
 <p>1 x BA1 (BA1/M) Mounting Base, 1" x 3" x 3/8"</p>	 <p>1 x FH2 Filter Holder</p>	 <p>1 x FGL780M 780 -1800 nm Colored Glass Filter, SM1-Threaded Mount</p>
 <p>1 x SM1SMA SMA Fiber Adapter Plate with External SM1 Thread</p>	 <p>1 x Zero Order Blocking Mask NBK7 Glass Substrate with 1.25 mm Central Spot</p>	 <p>1 x SM1L03 Ø1" Lens Tube, 0.30" Long</p>
 <p>1 x SMR1(/M) Lens Mount with No Retaining Lip for Ø1" Optics, 8-32 (M4) Tap</p>	 <p>3 x USB-C-72 72" USB 2.0 Type-A High-Speed Extension Cable, Black</p>	

Lamp

 <p>1 x QTH10 (QTH10/M) Quartz Tungsten-Halogen Lamp</p>	 <p>1 x SM2A6 Adapter with External SM2 Threads and Internal SM1 Threads</p>	 <p>1 x FGB37M Mounted Ø25 mm BG40 Colored Glass Bandpass Filter, 335 - 610 nm</p>
 <p>1 x HSLT2 Passive-Heat-Sink SM1 Lens Tube with External SM2 Threads</p>	 <p>1 x SM1CP2 End Cap, External SM1 Threads</p>	



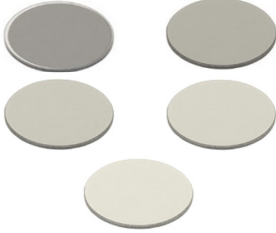

Collector and Field Stop

 <p>1 X LA1027 Ø1" N-BK7 Plano-Convex Lens, f = 35 mm, Uncoated</p>	 <p>1 x ID25 (ID25/M) Mounted Iris Diaphragm, Ø25.0 mm Max Aperture</p>
--	---

Neutral Density Filter Wheel

 <p>1 x CFW6 (CFW6/M) 30 mm Cage Filter Wheel</p>	 <p>1 Each of ND05B, ND10B, ND13B, ND20B, ND30B Neutral Density Filters: OD 0.5, 1.0, 1.3, 2.0, 3.0</p>
---	--



Spectral Filtering

 <p>2 x TRF90 (TRF90/M) 90° Flip Mount for Ø1" Filters and Optics</p>	 <p>1 x ER1 Ø6 mm Cage Assembly Rod, 1" Long</p>	 <p>1 x Colored Glass Bandpass Filter Ø25 mm VG9, 3 mm Thick</p>
 <p>1 x FBH520-40 Ø25 mm Premium Bandpass Filter, 520 nm CWL, 40 nm FWHM (Fluorescence Excitation Filter)</p>		

Condenser Optic

 <p>1 x SM1V10 Ø1" Adjustable Lens Tube, 1" Travel</p>	 <p>1 x AC254-050-A Ø1" Achromatic Doublet, f = 50.0 mm, 400 - 700 nm</p>	 <p>1 x SM1M10 SM1 Lens Tube, 1" Long, Two Retaining Rings Included</p>
 <p>1 x SM2D25 SM2 Lever-Actuated Iris Diaphragm (Ø0.8 - Ø25 mm)</p>	 <p>1 x SM1A2 Adapter with External SM1 Threads and Internal SM2 Threads</p>	

Sample Stage

 <p>1 x MS1S + Metric Micrometer (MS1S/M) 6.5 mm Travel Single-Axis Translation Stage with Side-Mounted Metric Micrometer</p>	 <p>1 x XYF1 (XYF1/M) XY Mount for 1" - 3" Rectangular Optics</p>	 <p>1 x Sample Stage Adapter Connects MS1S (MS1S/M) to XYF1 (XYF1/M)</p>
---	---	--

Plano-Convex (PCX) Objective

 <p>1 x LA1951 Ø1" N-BK7 Plano-Convex Lens, f = 25.4 mm, Uncoated</p>	 <p>1 x SM1RRC Extra-Thick SM1 (1.035"-40) Threaded Retaining Ring</p>
---	--



Achromatic Objective

 <p>1 x SM05V05 Ø1/2" Adjustable-Length Lens Tube, Rotating, 0.3" Travel</p>	 <p>1 x SM05M05 SM05 Lens Tube, 1/2" Long, Two Retaining Rings Included</p>	 <p>1 x SM05RC (SM05RC/M) Slip Ring for SM05 Lens Tube</p>
 <p>1 x SM1A1 Adapter with External SM05 Threads and Internal SM1 Threads</p>	 <p>1 x SM1D12C Calibrated Ring-Activated SM1 Iris Diaphragm</p>	 <p>1 x AC127-025-A Ø1/2" Achromatic Doublet, f = 25.0 mm, 400 - 700 nm</p>

Nikon Objective

 <p>1 x N10X-PHE 10X Nikon Phase Contrast Objective, Apodized Dark Low Phase Type, 0.25 NA, 6.2 mm WD</p>	 <p>1 x SM1A12 External SM1 to Internal M25 Thread Adapter (for Nikon Objective)</p>
---	--

Beamsplitter

 <p>1 x LMR2 (LMR2/M) 2" Fixed Lens Mount</p>	 <p>1 x EBP2 Ø2" 70:30 Beamsplitter</p>
---	---

Sample Camera

 <p>1 x DCC1545M High-Resolution USB2.0 CMOS Camera, 1280 x 1024, Monochrome</p>	 <p>1 x SM1V10 Ø1" Rotating Adjustable Lens Tube, 1" Travel</p>	 <p>3 x SM1L10 Ø1" Lens Tube, 1" Long</p>
 <p>1 x SM1L30 Ø1" Lens Tube, 3" Long</p>	 <p>1 x SM1L05 Ø1" Lens Tube, 0.5" Long</p>	 <p>1 x AC254-200-A Ø1" Achromatic Doublet, f = 200.0 mm, 400 - 700 nm</p>







Fluorescence Emission Filter

 <p>1 x FELH0550 550 nm Premium Longpass Filter (Fluorescence Emission Filter)</p>	 <p>1 x SM1L05 Ø1" Lens Tube, 0.50" Long</p>	 <p>1 x SM1CP1 Internally SM1-Threaded End Cap</p>
--	--	--

Back Focal Plane Camera

 <p>1 x DCC1645C High-Resolution USB2.0 CMOS Camera, 1280 x 1024, Color</p>	 <p>1 x SM1V10 Ø1" Adjustable Lens Tube, 1" Travel</p>	 <p>1 x SM1L10 Ø1" Lens Tube, 1" Long</p>
 <p>1 x LA1027 Ø1" N-BK7 Plano-Convex Lens, f = 35.0 mm, Uncoated</p>		

LED Mounts

 <p>4 x SMR05 (SMR05/M) Ø1/2" Fixed Lens Mounts with No Retaining Lip</p>	 <p>3 x LEDMT1E LED Mount, 51 Ω</p>	 <p>1 x LEDMT1F LED Mount, 62 Ω</p>
 <p>2 x LED405E Epoxy-Encased LED, 405 nm, 10 mW, T-1 3/4 (Use with LEDMT1E Mount)</p>	 <p>1 x LED528EHP Epoxy-Encased LED, 525 nm, 7 mW, T-1 3/4, Qty. of 5 (Use with LEDMT1E Mount)</p>	 <p>2 x LED631E Epoxy-Encased LED, 635 nm, 4 mW, T-1 3/4 (Use with LEDMT1F Mount)</p>
 <p>1 x LED940E Epoxy-Encased LED, 940 nm, 18 mW, T-1 3/4, Qty. of 5 (Use with LEDMT1E Mount)</p>		





Polarization Mounts

 <p>1 x Linear Polarizer Film Laser Cut to 3 x Ø1" Circles</p>	 <p>1 x SM1L03 Ø1" Lens Tube, 0.30" Long</p>	 <p>1 x RSP1D (RSP1D/M) Ø1" Rotating Polarizer Mount</p>
--	--	--







Storage

 <p>1 x Benchtop Organizer</p>	 <p>1 x Storage Box for 25 Slides</p>	 <p>1 x Plastic Storage Bin</p>
--	---	---

Accessories

 <p>1 x Flexible Ruler</p>	 <p>1 x Aluminum Foil Roll 300 mm Wide, 10 m Long, 15 µm Thick</p>	 <p>1 x Highlighter Set Pack of 4 Colors</p>
 <p>1 x LED Overhead Light</p>	 <p>1 x Small LED Flashlight USB Rechargeable</p>	 <p>1 x Clear Nail Polish</p>
 <p>1 x Adhesive Printed Labels for Parts</p>	 <p>1 x Roscolux Pattern Booklet Optical Filters</p>	 <p>1 x Tape Dispenser Matte Finish</p>
 <p>1 x USB Stick Containing Supplementary Documentation</p>	 <p>1 x CS1 Screw-On Cable Straps, Pack of 15</p>	 <p>1 x CAPM Black Rubber Dust Caps for Optical Fiber with Ø3.2 mm Ferrules, 10 Pack</p>

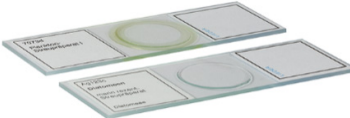
Samples

 <p>1 x R1L3S11P Positive Combined Resolution and Distortion Test Target, 3" x 1"</p>	 <p>1 x H&E Stained Histology Slides: Carolina Biosciences No. 317120, 317798, 318090, 316542</p>	 <p>1 x T14792 Invitrogen Molecular Probes TetraSpeck Fluorescent Microspheres Size Kit (Mounted on Slide)</p>
 <p>1 x Abbe Slides Abbe Image and Text (3 Slides)</p>	 <p>1 x Plankton (7073d) 1 x Diatoms (Ag123c) Marine Life Samples</p>	 <p>1 x FSK5 Fluorescent Microscope Slides, Set of 5 Colors</p>

Imperial Hardware Kit

Type	Qty. (Spare)	Placement
1/4"-20 Cap Screw, 1/2" Long	8	RDF1 to Breadboard
1/4"-20 Cap Screw, 3/8" Long	4	XT34HP to RS2P
1/4"-20 Cap Screw, 5/16" Long	1	TR4 to BA1 Multi-Purpose Mount
1/4"-20, Cap Screw, 1/4" Long	4	XT34HP to Right Angle Rail Mount
1/4"-20, Cap Screw, 1/4" Long	6	CS1 Strain Relief + Washers
8-32 Cap Screw, 3/4" Long	1 (1)	Adapter to XYF1
8-32 Cap Screw, 1/2" Long	2	Adapter to MS1S
8-32 Cap Screw, 3/8" Long	(2)	SM1RC Slip Ring
1/4"-20 Setscrew, 1/2" Long	1	CFW6 Filter Wheel
Thumbscrew	12	R2T Slip-On Post Collar
8-32 Setscrew, 1/4" Long	(2)	HKTS-3/16 Hex Key Thumbscrew
8-32 Nylon-Tipped Setscrew, 3/16" Long	(2)	Setscrews in XYF1 Slide Mounting
Washer for 1/4"-20 Cap Screw	6	CS1 Strain Relief
1/4"-20 to 8-32 Adapter Screw	1	MS1S Stage to Ø1/2" Post

Metric Hardware Kit

Type	Qty. (Spare)	Placement
M6 Cap Screw, 12 mm Long	8	RDF1 Breadboard Feet
M6 Cap Screw, 10 mm Long	4	XT34HP/M to RS2P/M
M6 Cap Screw, 8 mm Long	1	TR100/M to BA1/M Multi-Purpose Mount
M6 Cap Screw, 6 mm Long	4	XT34HP/M to Right Angle Rail Mount
M6 Cap Screw, 6 mm Long	6	CS1 Strain Relief + Washers
M4 Cap Screw, 20 mm Long	1 (1)	Adapter to XYF1/M
M4 Cap Screw, 12 mm Long	2	Adapter to MS1S/M
M4 Cap Screw, 10 mm Long	(2)	SM1RC/M Slip Ring
M6 Setscrew, 12 mm Long	1	CFW6/M Filter Wheel
Thumbscrew	12	R2T Slip-On Post Collar
8-32 Setscrew, 1/4" Long	(2)	HKTS-5M Hex Key Thumbscrew
8-32 Nylon-Tipped Setscrew, 3/16" Long	(2)	Setscrews in XYF1/M Slide Mounting
Washer for M6 Cap Screw	6	CS1 Strain Relief
M6 to M4 Adapter Screw	1	MS1S/M Stage to Ø12.7 mm Post

Chapter 5 Setup and Adjustment

This chapter discusses how to assemble the various components and explains how to set up and adjust the microscope. Screws are either contained with the components or can be found in the bag labeled *Hardware Kit*.

5.1 Breadboard and Rail Assembly

1. Attach the RDF1 damping feet to the bottom side of the 8" x 36" (200 mm x 900 mm) breadboard using eight 1/4"-20 (M6) cap screws [1/2" (12 mm) long].



2. Use the right angle rail adapter and attach 2 x XT34HP (XT34HP/M) dovetail mounting clamps with 4 x 1/4"-20, 5/16" (M6, 8 mm) cap screws. Use the provided lip to align the two clamps exactly perpendicular.

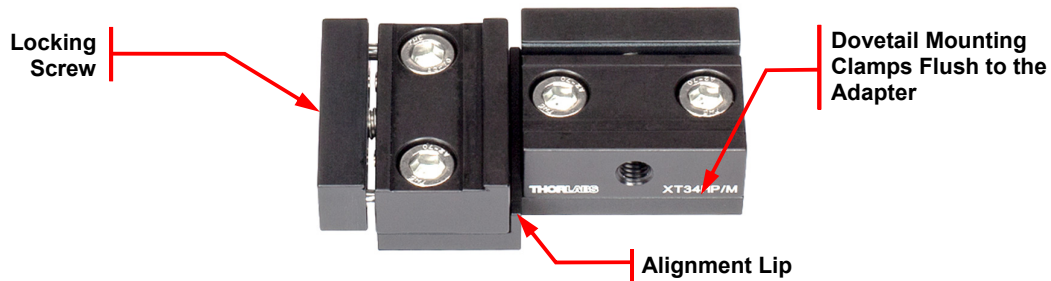

3. Open the locking screws on the side of the XT34HP (XT34HP/M) and slide it onto the two rails. Align the two rails against each other and with a 10.4" (26.5 cm) offset from the left side of the long rail to the left side of the short rail as shown below. **IMPORTANT: steps in the Lab Notes will not work properly if this distance is not close to 26.5 cm, which will cause problems for students (and thus instructors) in class.** Tighten the locking screws on the long rail first, then on the short rail. Check the rigidity and perpendicularity of the configuration.



4. Use the 4 x 1/4"-20, 3/8" (M6, 10 mm) cap screws to attach 4 x XT34HP (XT34HP/M) dovetail clamps to 4 x RS2P (RS2P/M) pedestal pillar posts.



5. Attach the pillar posts with the XT34HP (XT34HP/M) dovetail clamps to the rail in an evenly distributed configuration.

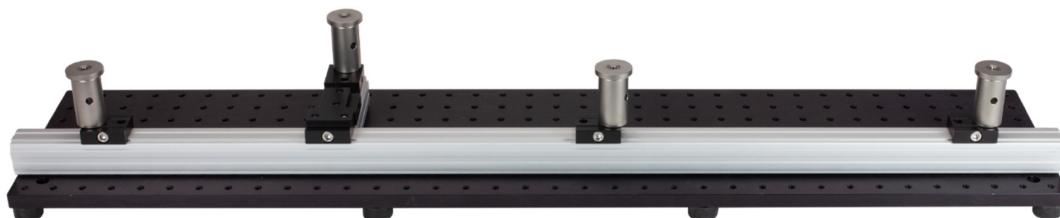

6. Flip the rail and attach the pillar posts to the breadboard with the CF175C (CF175C/M) clamping fork so that the rail is parallel on the breadboard and the dogleg points towards you as shown below. It is helpful if:
 - a. Rail ends do not extend beyond edge of breadboard
 - b. The long rail runs along (or parallel to) the tapped-hole pattern of the breadboard
 - c. The side of the long rail opposite of the short rail is approximately 5 - 6 cm (2 - 2.5 inches) from the edge of the breadboard; the short rail should also not protrude beyond the breadboard edge.

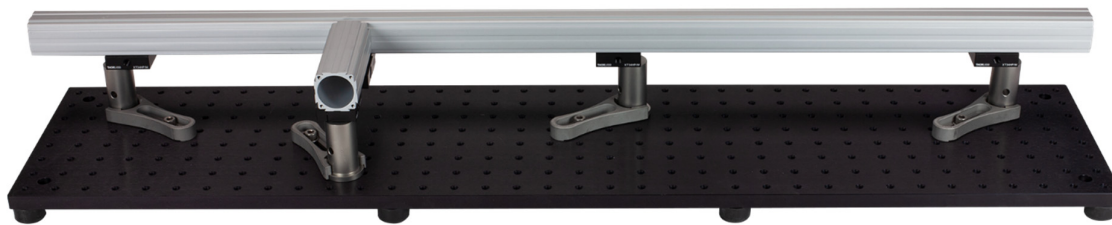

5.2 Optics Subassemblies

The following section shows how to assemble the optical components. Handling lenses and optics in general requires the use of powder-free gloves. You can find these in all sizes within Thorlabs' Optics Lab Supplies².

Included in the kit is a benchtop organizer to store the optics and balldrivers. The balldrivers can also be used with the through holes as a lever on the posts to tighten the posts to the optics holders. Imperial balldrivers have a yellow handle, while metric balldrivers have a red handle. The respective balldrivers are included in the kit.

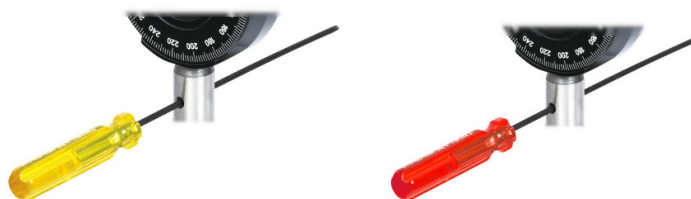

Figure 6 Using the balldriver for leverage on a $\varnothing 1/2$ " Post

Additionally a plastic bin to store spare parts, slip-on post collars, and tools is provided with the kit. It should be placed next to the optical rail for a quick access to these parts during the course.



Figure 7 Plastic Storage Bin

² https://www.thorlabs.com/newgrouppage9.cfm?objectgroup_id=1453

To secure lenses in the lens tubes, retaining rings are used. These can be tightened with the included spanner wrenches, SPW602 for 1" optics and SPW603 for 1/2" optics. A 2" spanner wrench (SPW604) is not included in the kit, but can be obtained from Thorlabs³. Further assembly tips can be found on our product videos⁴.



Figure 8 Included Spanner Wrenches

A label sheet is provided to tag parts and to indicate transmission directions. The formal convention is: Arrows should always be directed towards the camera (i.e., in the direction the light will be traveling).



Figure 9 Adhesive Label Sheet

5.2.1 Halogen Lamp Assembly

1. The halogen lamp has two sides and both are covered with end caps. On one side is the collimation lens and on the other side is the bulb next to the bulb socket. The cap in front of the collimation lens side has a knurled edge. The cap with access to the filament does not have a knurled edge to allow for easy access to the electrical parts.



Warning

Do not open the filament side with the lamp plugged in the power supply.



Remove the power supply if attached and remove the end cap to access the filament socket. The cap can be unscrewed by hand using light pressure, or with special tools from Thorlabs, such as the spanner wrench Item #'s SPW909 or SPW801 (sold separately).



³ <https://www.thorlabs.com/thorproduct.cfm?partnumber=SPW604>

⁴ <https://www.thorlabs.com/OMC>, See the *Videos* Tab

2. Loosen the setscrew for the bulb socket and remove it from the lamp.



3. Insert the bulb into the socket with gloves and put the socket back into the lamp, as shown below. Adjust the socket and tighten the setscrew so that the filament of the bulb is in the center of the lamp, at the cylinder axis and perpendicular to it. **IMPORTANT: setting the filament orthogonal to the axis now will help during the labs.**
 - a. Tighten the setscrew sufficiently to hold well, but not so tight it damages the ceramic socket.



4. Take the FGB37M mounted filter (335 - 610 nm) and screw the filter on the SM2A6 lamp adapter. Add the "FGB37 (IR)" adhesive label to the housing of the filter. (There is an engraving on the housing; you may decide to cover this with the label or keep both visible.)



5. Screw the lamp adapter with the filter into the open side of the lamp nearest to the bulb.
6. Unscrew the other end cap from the lamp (the side with the 2" collimating lens). Remove the two retaining rings from the HSLT2 heat sink and screw the heat sink on.

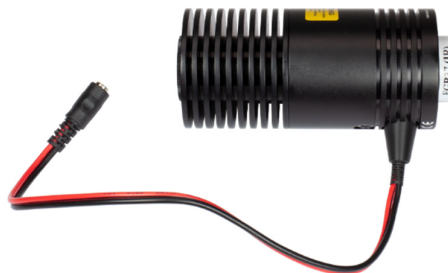

7. Add aluminum SM1CP2 end cap (not the plastic end caps) to the open side of the heat sink.



8. Mount the lamp on a TR3 (TR75/M) post.



9. Place the lamp's post in the benchtop organizer. The organizer also has through holes to hold the balldrivers included in the kit.



5.2.2 Collector Lens Assembly

1. Use the SPW602 spanner wrench to remove the retaining ring from the LMR1 (LMR1/M) optic mount and insert the LA1027 lens with the flat side facing the lip of the mount. Reinsert retaining ring into the mount to fix the lens into position as shown.



2. Add the "F = 35 mm PCX" (PCX: *plano-convex lens*) label to the top of the lens mount.
3. Place the mount into the benchtop organizer for storage.

5.2.3 Field Stop

1. The ID25 (ID25/M) field stop iris is preassembled as shown. A label "Field Iris" is provided to attach to either the field stop post or, at a later stage, on the XT34TR1 (XT34TR1/M) rail carrier it goes into during the assembly of the kit. When putting the label on the post, place it high, near the cross-drilled hole (as shown).



2. Place the iris into the benchtop organizer for storage.

5.2.4 Filter Wheel Assembly

1. Use the SPW602 spanner wrench to remove the retaining rings from the CFW6 (CFW6/M) filter wheel.
2. Open the case of the ND05B filter and determine which side is metalized by looking through its edges as shown below. Note: the metalized side shows no transparent ring when looked at from an angle (right image).



Metallized Side Facing Down



Metallized Side Facing Up

3. Place the CFW6 (CFW6/M) filter wheel in front of you so you can insert the optics. Insert the ND05B filter with the metalized side **upward** (facing you) into the CFW6 (CFW6/M) filter wheel and secure the filter with the retaining ring. Do not tighten the retaining ring too tightly. Use the adhesive labels to indicate the ND value (attenuation) and filter direction (arrow on the label should face **away** from the metalized side of the filter). When the filter wheel is placed on the rail, the metalized side of the filters should face toward the lamp.



4. Repeat steps 2 and 3 with ND10B, ND13B, ND20B and ND30B filter subsequently in this order and label them accordingly. **Metallized sides of all filters should face the same direction.**
5. Add the label "Open" to the remaining filter wheel optic mount (the one with no filter installed).
6. Attach the 1/4"-20 (M6) setscrew [1/2" (12 mm) long] to one of the central mounting holes.



7. Attach the TR3 (TR75/M) post with the 1/4"-20 (M6) threaded side to it and remove the 8-32 (M4) setscrew from the other end of the post.
 - a. When securing the post, **DO NOT** use the filter wheel for leverage. Rather, put a driver through the 6 mm rail hole on the filter wheel body, and another through the cross-drilled hole in the post, and use these for leverage.



8. Place the mount into the benchtop organizer for storage.

5.2.5 Flip Mount Assembly

1. Use the SPW602 spanner wrench to remove the retaining rings from the two TRF90 (TRF90/M) 90° flip mounts. The mount has various locking and mounting screws shown below. A 0.05" (1.3 mm) hex key is provided with the item.

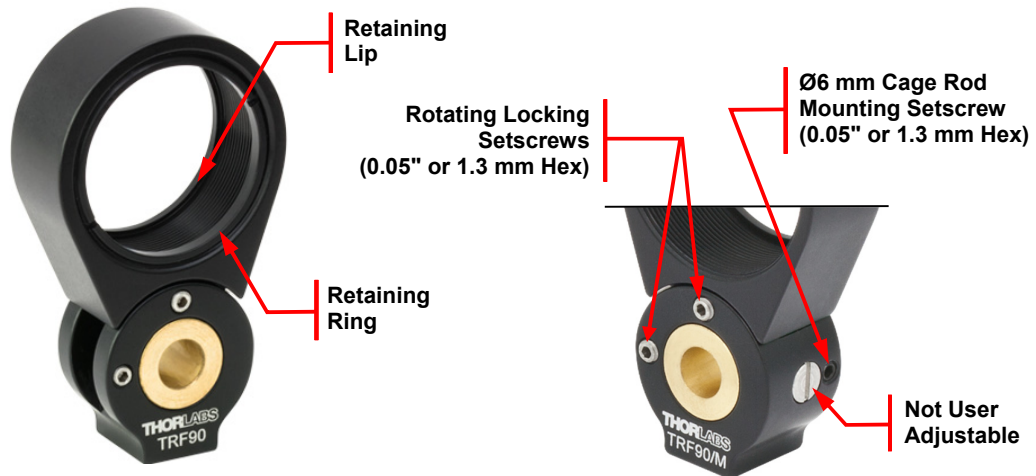

2. Insert the FBH520-40 band pass filter with the arrow on its housing pointing **away** from the lip of the TRF90 (TRF90/M) flip mount. Fix the optic with the retaining ring and apply the corresponding adhesive label "FBH520-40 (ex)". The adhesive label arrow should point in the same direction as the label on the housing of the filter **away** from the lip of the flip mount.



3. Insert the FGV9-3MMT-SP band pass filter in the other TRF90 (TRF90/M) mount, and fix it with a retaining ring. Since the filter is an absorption filter, the orientation does not matter. Add the adhesive label "FGV9-3mm"



4. To combine these two elements we use an ER1 cage rod. Unscrew the setscrews from the ends of the rod. Insert the rod in the holes of the two TRF90 (TRF90/M) flip mounts. Tighten the cage rod mounting setscrew on the side of both flip mounts firmly to fix the mounts into the position as shown.



- Screw a TR3 (TR75/M) post into one of the TRF90 (TRF90/M) flip mounts with the FGV9 filter installed.



- Place the flip mount into the benchtop organizer for storage.
- Place the hex key in the plastic bin.

5.2.6 Condenser Assembly

- Screw the TR3 (TR75/M) post to the SM1RC (SM1RC/M) slip ring and set it aside. Check that the setscrew from the post does not protrude into the interior of the slip ring aperture (where the SM1 tube will go).



- Screw the SM1A2 adapter onto the SM2D25 lever-actuated iris diaphragm. **Be careful** not to put pressure on the iris lever. The best practice is to not touch the lever while tightening.



- Remove the two retaining rings from the SM1M10 lens tube (can be done by hand) and attach the SM1A2 adapter to the SM1M10 lens tube.



- Insert the SM1M10 lens tube into the previously assembled SM1RC (SM1RC/M) slip ring and tighten it with the locking screw on top of the slip ring.



- Unscrew the retaining ring from the SM1V10 adjustable lens tube and insert the AC254-050-A lens **with the flat side (lower curvature) towards the inner lip of the SM1V10**. Fix the lens into position with the retaining ring.
- Add the adhesive label "F = 50mm Ach" to the adjustable lens tube.

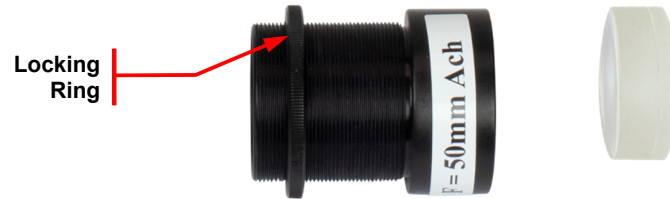

- Screw the SM1V10 variable lens tube into the previously assembled SM1M10 lens tube. Lens focus position and locking will be set later during the alignment process.

→ The final assembly should look like the figure below:

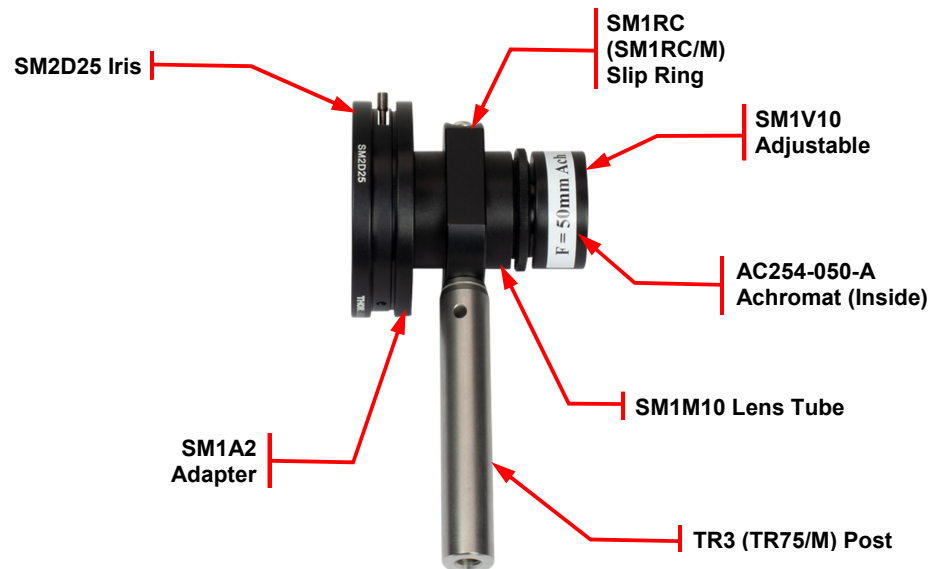

- Place the assembly into the benchtop organizer for storage.

5.2.7 Sample Stage Assembly

The MS1S (MS1S/M) sample stage is fitted with a suitable *metric* micrometer adjuster. On the Imperial product, this is a special configuration labeled MS1S-SP.

- Use the two dowel pins provided with the MS1S-SP (MS1S/M) stage and insert them in the top part.

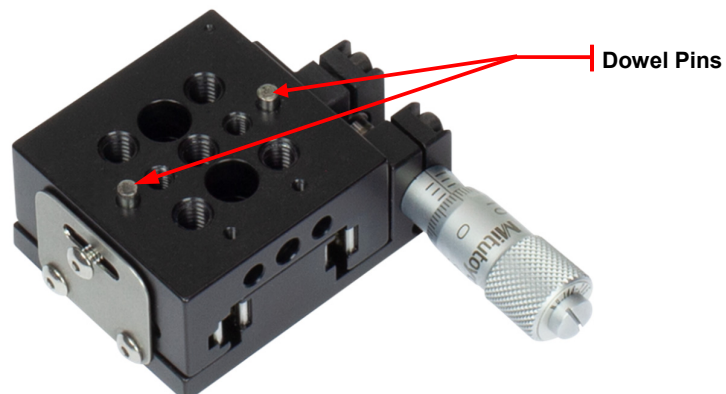

2. Use two 8-32 (M4) cap screws, 1/2" (12 mm) long, and screw the MS1S stage adapter to the MS1S-SP (MS1S/M) stage as shown in the image. The dowel pins are tight fit and will make a precise orthogonal alignment. In order to avoid placing strain on (and damaging) the delicate ball-bearings, **hold the top portion of the MS1S-SP (MS1S/M) stage while securing the adapter to it.**
 - a. **IMPORTANT:** The adapter plate lip (see figure) should face away from the stage micrometer.

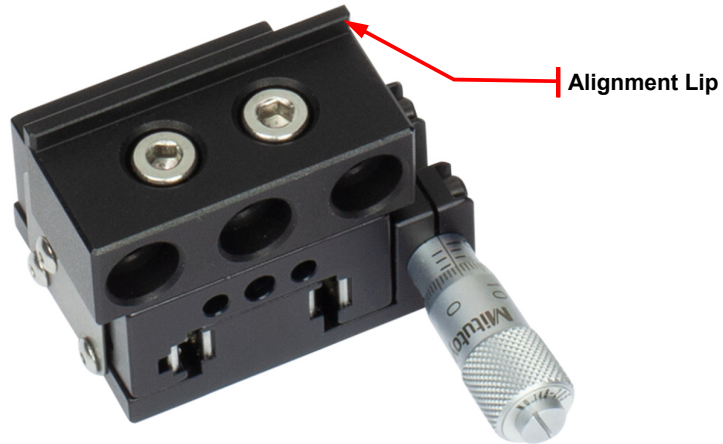

3. Attach the XYF1 (XYF1/M) slide holder stage with an 8-32 (M4) cap screw, 3/4" (20 mm) long, to the adapter through the **central** countersunk hole.

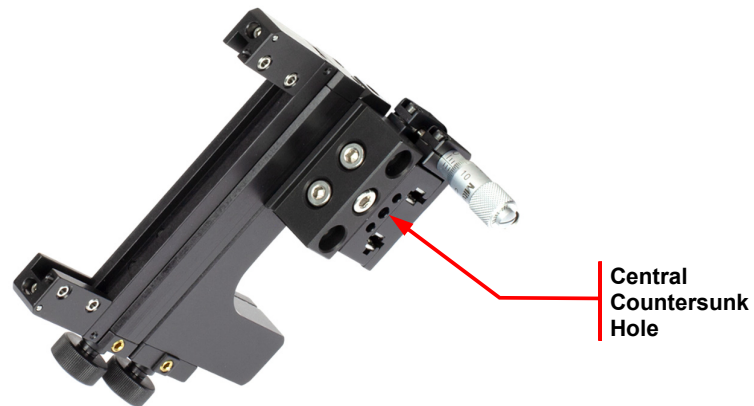

4. Screw the AP8E25E (AP6M4M) adapter screw [1/4"-20 to 8-32 (M6 to M4)] into the bottom part of the stage. In this case, to avoid damage to the ball-bearings, avoid strain on the stage during the attachment by **holding the bottom** part of the stage while tightening.

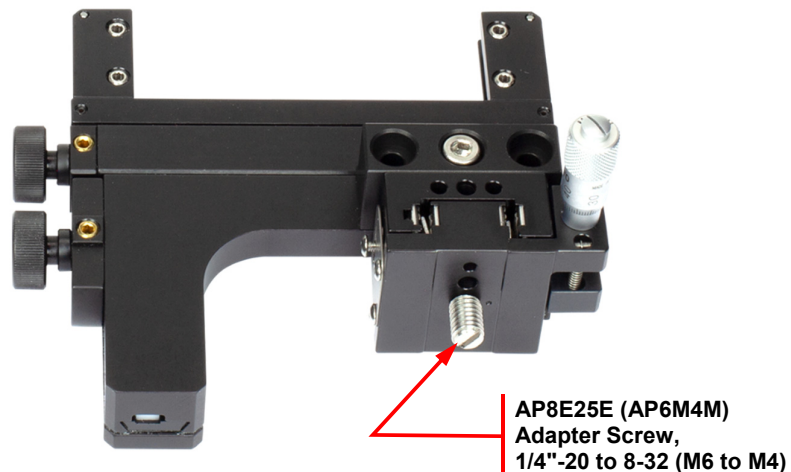

- Remove the setscrew from the TR2 (TR50/M) post and screw the post upside down on the bottom of the MS1S-SP (MS1S/M) stage. To avoid damage to the ball-bearings, avoid strain on the stage during the attachment by **holding the bottom** part of the stage while tightening. The finished stage is shown below:

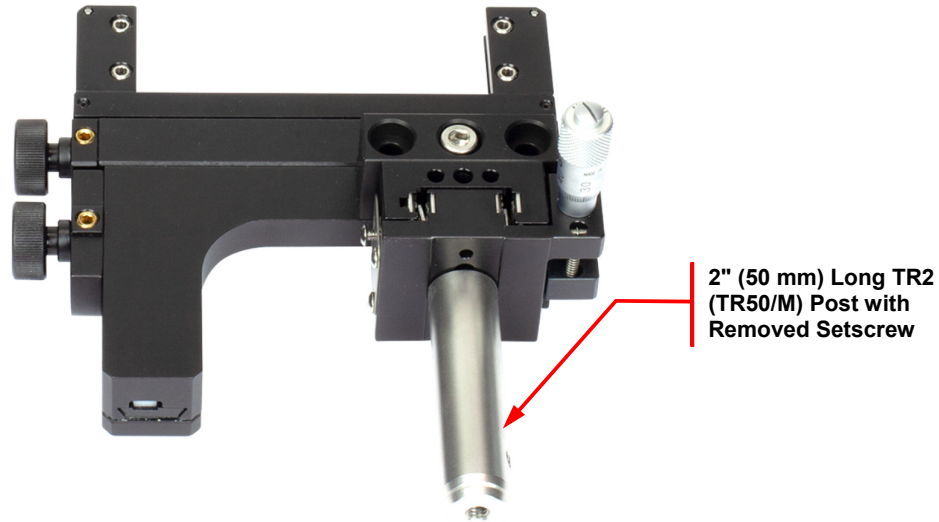

- Place the assembly into the benchtop organizer for storage.

5.2.8 PCX Objective Assembly

- Remove the retaining ring from the LMR1 (LMR1/M) lens mount.
- Insert the LA1951 lens with the flat side against the lip of the lens mount. The image below shows the LMR1 (LMR1/M) lens mount and the extra thick plastic SM1RRC retaining ring, which is used to secure optics with high curvature, such as this one.



- Use the SM1RRC extra-thick retaining ring to fix the lens into position. The retaining ring has two sides. Use the thickest part of the retaining ring against the lens.
- Screw the TR3 (TR75/M) post into the LMR1 (LMR1/M) optic mount.
- Put the adhesive label "F = 25 mm PCX" onto the assembly.
- Place the assembly into the benchtop organizer for storage.



5.2.9 Achromatic Objective Assembly

- Screw the TR4 (TR100/M) post into the SM05RC (SM05RC/M) slip ring for SM05 lens tubes and set it aside.

2. Screw the SM1A1 adapter onto the SM1D12C iris diaphragm. Be careful not to grip (and thus strain or damage) the iris closing mechanism while tightening the adapter. Be careful to instead hold the (non-turning) lip of the iris mechanism while securing the adapter.



3. Remove the retaining rings from the SM05M05 lens tube (with two internal threads) and attach it to the previously assembled iris and the adapter.



4. Insert the lens tube into the previously assembled SM05RC (SM05RC/M) slip ring. Align the iris with the scale on top and tighten the locking screw.



5. Remove the retaining ring from the SM05V05 adjustable lens tube. Insert the AC127-025-A lens into the SM05V05 lens tube with the curved side **towards the inner lip** and fix it into position with the retaining ring.



6. Attach the SM05V05 lens tube to the previously assembled SM05M05 lens tube.
7. Attach the adhesive label "F = 25mm Ach" (has smaller font size) to the achromatic objective in the adjustable lens tube.

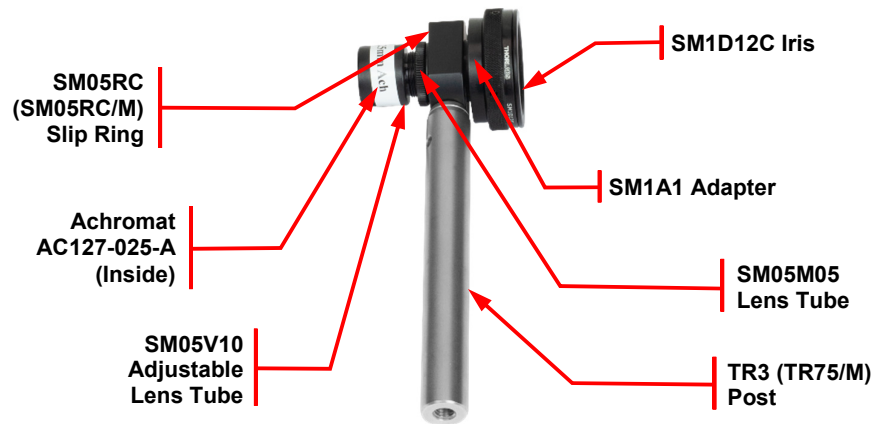

- Attach the adhesive label “BFP Iris” to the mount. The placement should be on the fixed part of the iris mount, but not on the rotating part. Do not cover the scale on the SM1D12C iris. You can also choose a different placement on the slip ring, around the post or on the respective rail carrier (although these might get swapped).
- Place the assembly into the benchtop organizer for storage.

5.2.10 Back Focal Plane (BFP) Beamsplitter Assembly

- Remove the retaining ring from the LMR2 (LMR2/M) 2" diameter lens mount.
- Open the box of the EBP2 beamsplitter. The beamsplitter has an exposed oxide coating on one side and is uncoated on the other side. You can determine the coated side similar to the neutral density filters shown below by looking through its edges.

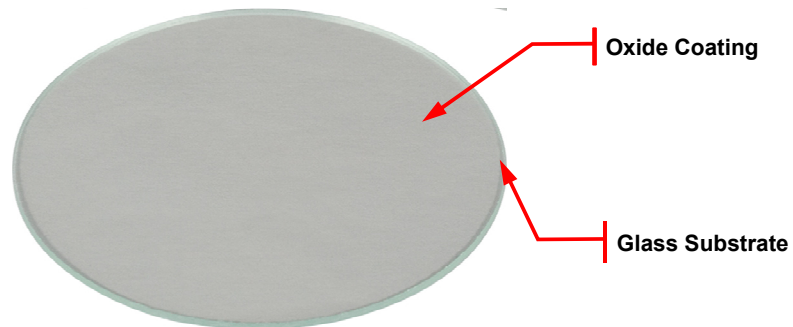

- Insert the EBP2 beamsplitter⁵ with the coating facing the lip of the LMR2 (LMR2/M) optic mount and tighten the retaining ring. You may use an available SM2 spanner wrench (not included in the kit) or carefully tighten it with a sharp (best would be plastic) tool to avoid scratching the optic.
- Attach the TR3 (TR75/M) post
- Add the “EPB2 70-30” adhesive label to the top of the mount.
- Place the assembly into the benchtop organizer for storage.



⁵ The EBP2 is an economy beam splitter with the two sides parallel. To minimize internal reflections, wedged beam splitters, e.g. the Thorlabs BSS16, can be used (<https://www.thorlabs.com/thorproduct.cfm?partnumber=BSS16>). We purposefully use this flat beamsplitter in the kit both for its cost effectiveness and because it allows us to have students investigate the secondary reflection, which provides a useful learning experience.

5.2.11 Microscope Objective (Nikon)

1. Remove the retaining ring from the LMR1 (LMR1/M) optic mount.
2. Screw the SM1A12 M25 thread adapter into the optic mount.
3. Attach the optic mount to the TR3 (TR75/M) post.



4. Attach the N10X-PHE Objective to the M25 thread adapter in the optic mount.
5. Place the assembly into the benchtop organizer for storage.
 - a. Note: store the phase contrast ring separately; it cannot be used in this kit, but can potentially be used in your own projects or in commercial Nikon microscopes.



5.2.12 Filter Holder Assembly

1. Remove the setscrew from a TR3 (TR75/M) post.
2. Attach the FH2 filter holder using its included 8-32 x 1/4" stainless steel (M4, 6 mm, black anodized) screw.
3. Place the assembly into the benchtop organizer for storage.



5.2.13 Polarization Mount Assembly

1. Unscrew the retaining ring from the LMR1 (LMR1/M) optic mount.
2. Take one polarizer from the box. The polarizers have a flattened edge which is parallel to the transmission axis. Additionally, it is covered by two layers of adhesive film. It is very helpful to place a piece of sticky adhesive tape over the edge of this film. When removing the tape, the protective film is then pulled off as

well. **To get a grip on the protective film, it might be necessary to cut along the flat edge of the film with scissors and use tweezers to peel the film off.** (Note: this is all best done while wearing gloves to keep the polarizer surfaces clean.) The result can be seen here:

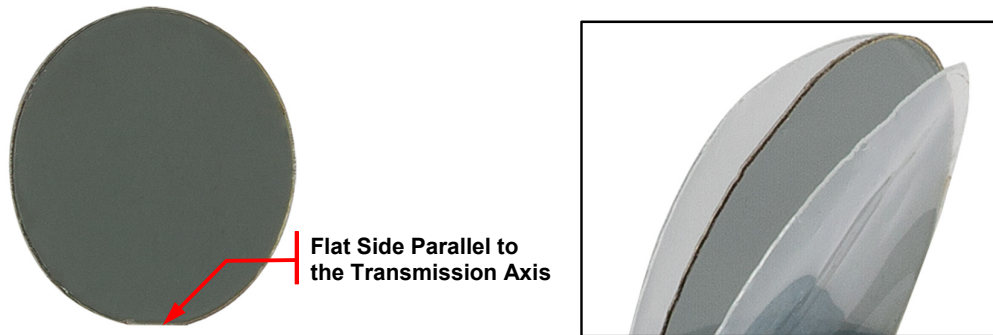

3. Remove the retaining ring from the short SM1L03 lens tube. Then put the bare polarizer sheet in the SM1L03 lens tube and fix it into position with the retaining ring.
4. Attach the lens tube to the LMR1 (LMR1/M) mount. The orientation of the polarizer in the mount will be random (this is intentional, for pedagogical purposes).
5. Add label "Polar I" to the optic mount.



6. Place the assembly into the benchtop organizer for storage.
7. Screw the retaining ring from the RSP1D (RSP1D/M) rotating polarizer mount all the way down to the inner lip (this broadens the inner lip). Repeat the previous steps and remove the adhesive films from the polarizer sheet and insert it into the polarizer mount against the retaining ring. Use one of the spare retaining rings (left over from previous assembly steps) and fix the polarizer into position. Thus, the orientation of the polarizer will be random in the mount. This is also intentional, for pedagogical purposes.
8. Add label "Polar I" to the optic mounts.



9. Place the assemblies into the benchtop organizer for storage.

5.2.14 Fluorescence Filter Assembly

1. Remove the retaining ring from a SM1L05 lens tube.
2. Insert the FELH0550 with the **arrow towards the inner lip of the lens tube** and fix it into position with the retaining ring.
3. Attach the corresponding adhesive label with the arrow towards the external threading of the lens tube, and put on an SM1EC2B end cap on one side of the tube and an SM1CP1 end cap on the other.
Putting end caps on both sides protects the delicate interference filter!



5.2.15 Diffuser Assembly

1. Attach a TR3 (TR75/M) post to a SM1RC (SM1RC/M) slip ring.
2. Use the scotch tape to cover the entire aperture of the slip-ring (three layers at approximately 120° angles works well).⁶

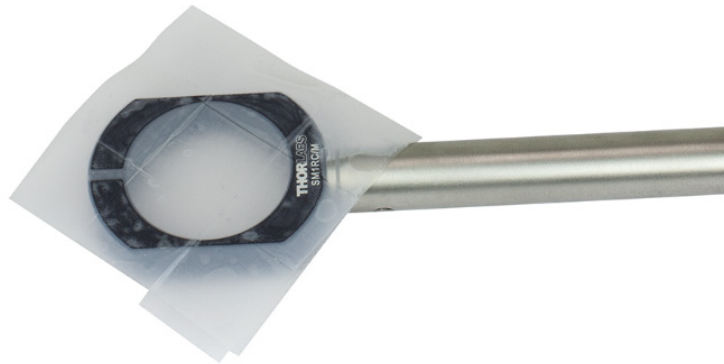

3. Trim away the excess tape.



4. Place the assembly into the benchtop organizer for storage.

5.2.16 LED and Multi-Purpose Mount Assembly

1. Screw four SMR05 (SMR05/M) optic mounts onto four TR4 (TR100/M) posts.
2. Use the arrow markings on the barrel of the LEDM1F LED mount (62 Ω resistor) as a template to cut the leads of the LED631E LED to the appropriate length. It is best to shorten them as shown below, such that the leads have noticeably different lengths, in order to tell the anode apart from cathode; to avoid confusion, shorten the smaller arm first. Once trimmed, slowly insert the LED into the LED mount. If it gets

⁶ There are also inexpensive, purchasable ground-glass (not to mention higher-performance engineered) diffusers available from Thorlabs; however learning to prototype with simple materials is a valuable skill, and one we wanted to emphasize for students in the class.

stuck before it is fully inserted, wiggle it or unplug the LED again then reinsert. The LED should go all the way into the mount.



3. Use the provided “Red” label and add it to the SMR05 (SMR05/M) mount. Alternately, you can label the LED mount itself in the provided white labeling area, using a permanent marker.
4. Screw the LED mount into one of the SMR05 (SMR05/M) post mounted optic holders.



5. Take an LED1ME LED mount (51 Ω resistor) and repeat the two previous steps with the LED405E LED, then repeat with the LED528EHP LED and LED940E LED. Add the “Blue,” “Green,” and “IR” labels, respectively, to the LEDs. To reiterate:
 - a. The red LED (item # LED631E) goes into the LEDM1F mount.
 - b. All the other LEDs go into the LEDM1E mounts, which have a different current-limiting resistor.
6. Check the LEDs Blue, Green, Red with the provided USB cable and the DS5 power supply or any available USB port. An example is show.



7. Place all of the LED assemblies into the benchtop organizer for storage.

5.2.17 Sample Camera Assembly

1. Remove the retaining ring from the SM1V10 adjustable lens tube.
2. Add the "F = 200mm Ach" label to the adjustable lens tube.
3. Insert the AC254-200-A achromatic lens with the flat side towards the inner lip and fix the lens in place with the retaining ring.

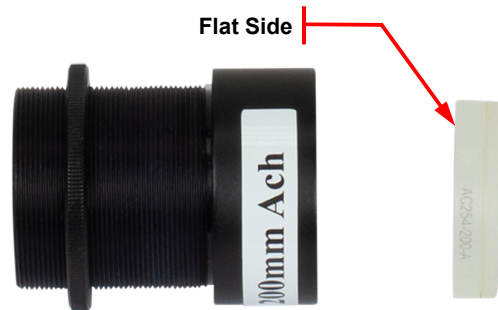

4. Remove the retaining ring from the SM1L10 lens tube and screw the previously assembled adjustable SM1V10 lens tube.



5. Remove the cover of the DCC1545M monochrome camera.



6. The camera box includes three adapter rings. Use the black adapter ring with external CS threading and internal SM1 threading (can be tested with any lens tube in the kit); screw it into the DCC1545M camera so that the internal SM1 threading faces away from the camera (allowing an SM1 tube to be attached later). Do not use excessive force to screw the adapter on.



7. Remove the retaining ring from the 3" (76.2 mm) long SM1L30 lens tube and attach it to the thread adapter now on the camera.
8. Screw a TR3 (TR75/M) post on an SM1RC (SM1RC/M) slip ring.



9. Insert the SM1L30 lens tube attached to the camera into the SM1RC (SM1RC/M) slip ring, and tighten the slip ring such that the camera is horizontally aligned. The $\frac{1}{4}$ "-20 (M6) tapped hole on the camera body should face in the same direction as the TR3 post on the slip-ring). The slip-ring should be near the far end of the SM1L30 from the camera.
10. Once the slip-ring is secured, screw the previously assembled focus mechanism assembly (SM1V10 with SM1L10) tubes onto the SM1L30.
11. Add the label "Mono Camera" to side of the camera facing you in the orientation as shown below.

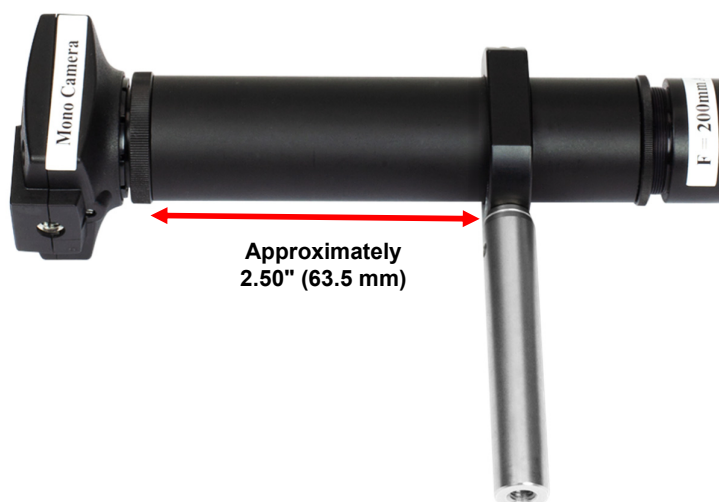

12. Put a lens cap (SM1EC2B) on the SM1V10 to cover the lens.
13. Place the assembly into the benchtop organizer for storage.
14. Two additional 1.00" (25.4 mm) SM1L10 lens tubes and one 0.5" (12.5 mm) SM1L05 lens tube are available – and necessary – to adjust the distance from camera to the lens. Place them in the plastic storage bin: they are **crucial** for the lab experiment done by students in Lab 2. If you want to set up the

system immediately yourself, then add the three lens tube to the camera mount above and start focusing the camera to infinity. The steps are provided in Lab 2 of the Lab Notes.



5.2.18 Back Focal Plane (BFP) Camera Assembly

1. Remove the retaining ring from the adjustable SM1V10 lens tube.
2. Insert the 35 mm focal length LA1027 PCX lens with the flat side facing the inner lip of the adjustable lens tube. Fix the lens into position with the retaining ring.



3. Add the label "F = 35mm PCX" to the SM1V10 lens tube.
4. Remove the cover of the DCC1645C color camera.
5. The camera includes three adapter rings. Use the black adapter ring with the external CS threading and internal SM1 threading; screw it into the DCC1645C camera so that the internal SM1 threading faces away from the camera (allowing an SM1 tube to be attached later). Do not use excessive force to screw the adapter on.



6. Remove the retaining ring from the SM1L10 lens tube and attach the lens tube to the camera adapter.



7. Screw the TR3 (TR75/M) post into the SM1RC (SM1RC/M) slip ring.
8. Insert the SM1L10 lens tube on the camera into the SM1RC (SM1RC/M) slip ring, and tighten the slip ring such that the camera is horizontally aligned (the 1/4"-20 (M6) tapped hole on the camera body should face in the same direction as the TR3 post on the slip-ring). The slip-ring should be near the middle of the SM1L01 on the camera (see figure below).
9. Screw the adjustable lens tube into the SM1L10 lens tube.
10. Add the label "Color Camera" to the side of the camera facing you when pointing to the right.

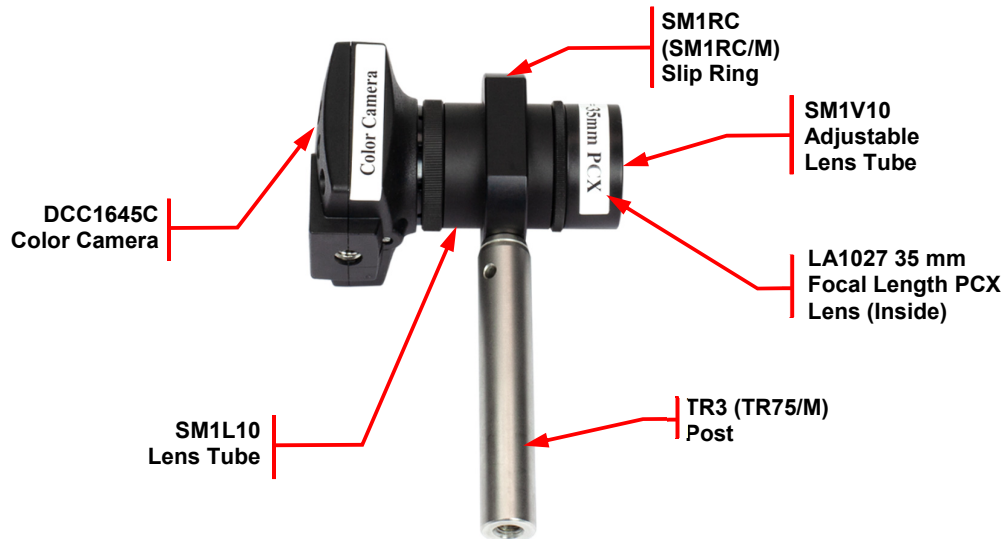

11. Attach one of the SM1EC2B end caps to the adjustable lens tube to cover the lens.
12. Place the assembly into the benchtop organizer for storage.

5.2.19 780 nm Longpass Assembly

1. Screw a LMR1 (LMR1/M) optic mount on a TR3 (TR75/M) mount.



2. Remove the retaining ring from the LMR1 (LMR1/M) and screw the preassembled FGL780M longpass filter on the optic mount.



3. Add the label "FGL780 LP" to the mount.
4. Place the assembly into the benchtop organizer for storage.

5.2.20 Multi-Purpose Mount Assembly

1. Remove the setscrew from a TR4 (TR100/M) post.
2. Attach the base to the post by using a cap screw 1/4"-20 x 3/8" (M6, 10 mm) through the counter sunk hole of the mounting base BA1 (BA1/M), attaching it to the 1/4"-20 (M6) internal thread in the end of the post.



3. Place the assembly into the benchtop organizer for storage.

5.2.21 Optical Fiber Mount

1. Screw the lens mount without a lip, the SMR1 (SMR1/M), onto a TR3 (TR75/M) post.



2. Add one of the spare retaining rings to the SMR1 (SMR1/M) mount with the provided spanner wrench 2 - 3 mm deep into the mount. This leaves you enough space to insert the SM1SMA fiber adapter on one side and a lens tube or filter on the other side of the retaining ring.



3. Screw the SM1SMA fiber adapter against the retaining ring and place the mount into the benchtop organizer for storage.



5.2.22 Zero Order Blocking Mask

1. Remove the retaining ring from an SM1L03 0.3" (7.6 mm) lens tube.
2. The Zero-Order Blocking Mask consists of an UV printed dot on a glass substrate. From one side you should see a bulge, which determines the UV printed side. Put it with the bulge facing down into the SM1L03 0.3" (7.6 mm) lens tube. Secure the optic with the retaining ring.



3. Add the "Zero Order Blocking Mask" label to the lens tube
4. Attach one of the SM1EC2B end caps onto the lens tube
5. Place this part in a safe place for storage, until called for (during Lab 6). One side is exposed, so be careful it is in a dust-free environment. It may make good sense to store these with the fluorescence interference filters (used in Labs 9 and 10, but also otherwise to be kept safe and away from dust).

5.3 Thin Slip-On Post Collars

The R2T slip-on post collars are an important tool to secure the optics height during vertical alignment. They can be used with the included setscrews or with the additionally provided thumbscrews in the hardware kit. The thumbscrews can be a great help, providing quick access to height adjustments without the need of a hex wrench. However, the thumbscrew of the post-collar can interfere with positioning against other optics (and/or the rail carrier); thus, the post collar should be mounted on the post with a slight angle between the two thumbscrews. Note: users fall into strongly divided camps as to thumbscrew vs. setscrew preference. Since they are inexpensive, we are providing both. The setscrews are standard; if you prefer thumbscrews (as the authors do) you must remove the setscrews from the post-collars and insert the thumbscrews.



Subassemblies that should receive a slip-on post collar include:

- Sample Camera
- Back Focal Plane Camera
- Objective Lens
- Condenser Lens
- Field Stop
- Collector Lens
- Lamp

Place the remaining height collars in the plastic bin next to the kit.

5.4 Strain Relief

Included in the kit are CS1 Screw-On Cable Straps with 6 x 1/4"-20, 1/4" (M6, 6 mm) cap screws and washers. These can be used as a strain relief for the camera's USB and the lamp's cables.

1. The use of the cable straps (as strain-reliefs) is **HIGHLY RECOMMENDED**. The mini-USB connections on the cameras can be damaged if the USB cable is yanked while connected, and especially in a classroom environment this is easily foreseeable. Consider using the cable straps to secure the camera (and potentially the spectrometer) USB cables, leaving just enough play to easily attach the cables to the cameras.

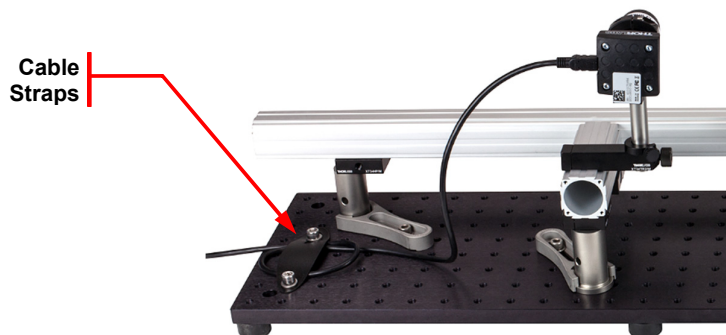

5.5 Overhead Lamp and LED Flashlight

Included in the kit is an LED Overhead Light (Daffodil ULT300). It can be clamped to a monitor, giving just enough light for students to take notes (and read the lab procedures) during the labs, but not interfering with low light microscopy measurements (or of other students). The lamp's power supply is via USB or battery (4 x AA not included). Note: repeated pressing of the power button cycles through three different illumination levels, which can be highly convenient.

During especially low light measurements, the supplied LED flashlight can be used. The LED flashlight has a USB port to charge it quickly.



5.6 Plastic Bin and Spare Parts

The following items should be placed in the plastic bin before the start of the course:

- Flexible Ruler
- Tape Dispenser
- 2 x Additional $\text{\O}1.00''$ ($\text{\O}25.4$ mm) Lens Tubes (See Section 5.2.17)
- 1 x Additional $\text{\O}1/2''$ ($\text{\O}12.5$ mm) Lens Tube (See Section 5.2.17)
- $\text{\O}30.0$ mm N-BK7 Plano-Convex Lens, $f = 75.0$ mm Uncoated PCX Lens (Used in Lab 1)
- $\text{\O}30.0$ mm N-BK7 Plano-Convex Lens, $f = 100.0$ mm Uncoated PCX Lens (Used in Lab 1)
- Slip-On Post Collars (with Thumb Screws)
- Rail Carriers
- Spanner Wrenches
- Lens Tissues
- Aluminum Foil
- Highlighters
- LED Flashlight
- Clear Nail Polish
- Roscolux Pattern Booklet
- 1 Pack Objective Slides
- 1 Pack Cover Slides
- USB Extension Cables



The following two items should be stored carefully, in a dust-free environment, until the labs when they are needed:

- Fluorescence Filter Assembly (See Section 5.2.14) (Used in Labs 9 and 10)
- Zero Order Blocking Mask (See Section 5.2.22) (Used in Lab 6, and students may want them in 7 and 8)

Chapter 6 Samples

All samples can be stored in the slide storage box for 25 slides, provided with the kit.

1. R1L3S11P Resolution Test Target

 <p>The image shows a rectangular slide with a white background. It features several resolution test patterns, including USAF 1951 and NBS1963a targets, and a set of Ronchi gratings. The slide is labeled 'THORLABS' at the top and 'R1L3S11P' at the bottom. There are also labels for 'REFERENCE SLIDE' and 'RESOLUTION SLIDE'.</p>	<p>This is a custom optical target designed specifically for this microscopy course. It contains multiple resolution targets (USAF 1951 and NBS1963a) as well as a set of different Ronchi spacings and several features from the original Abbe slides used to introduce his theory (and Zeiss microscopes) c. 1900. Despite their pedagogical utility, the Abbe slide elements have been out of production for decades until Thorlabs agreed to make this target for the kit.</p> <p>The targets are made by plating vacuum-sputtered, low reflectivity chrome with an optical density of ≥ 3 at 430 nm on a soda lime glass substrate.</p> <p>Do not touch the glass with bare hands. We advise storing them in the plastic boxes they are shipped in, and to encourage users to treat them carefully and protect them from dust when not in use.</p>
--	--

2. Bead Sample

 <p>The image shows a slide with a blue background and six circular wells. The wells are numbered 1 through 6. Below the wells, there is a label with the following text: '4 1 0.5 0.2 0.1 Mix'. The slide is labeled 'invitrogen by Thermo Fisher Scientific' and 'TetraSpeck™ Kit'.</p>	<p>Invitrogen Molecular Probes TetraSpeck Fluorescent Microspheres Size Kit (Mounted on Slide).</p> <p>Position 1: 4.0 μm Microspheres Position 2: 1.0 μm Microspheres Position 3: 0.5 μm Microspheres Position 4: 0.2 μm Microspheres Position 5: 0.1 μm Microspheres Position 6: Mounted Mixture of All Five Sizes.</p> <p>Storage Requirements: Store at room temperature and protect from light. Do not freeze.</p> <p>A label for the bead sizes can be found on the label sheet.</p>
---	---

3. Abbe Slides

 <p>The image shows a slide with a white background. It features a printed photograph of Ernst Abbe and text for imaging conjugate optical planes. The slide is labeled 'ERNST ABBE' at the bottom.</p>	<p>Three slides of a printed photography of Ernst Abbe and text for imaging conjugate optical planes in the setup during Lab 6.</p> <p>For demonstration purposes, two of the slides have to be removed from their plastic covers. Break the cover off to access the whole slide.</p> <p>There are no special storage requirements for these slides.</p>
--	--

4. Tissue Samples

	<p>H&E stained histology slides:</p> <ul style="list-style-type: none"> #317120 Human Myocardial Infarct Microscope Slides #317798 Human Adenocarcinoma of Lung #318090 Human Metastatic Carcinoma to Liver #316542 Human Prostate Gland – Young <p>Storage requirements: protect the slides from light when not in use, e.g. by storing them in the (provided) opaque slide storage box.</p>
---	---

5. Fluorescent Microscope Slides

	<p>These slides excite and emit at five different sets of wavelengths, similar to a variety of fluorophores (See the Fluorescence Graphs Tab).</p> <p>Dimensions: 25.4 mm x 76.2 mm, 1.7 mm thickness.</p> <p>Storage requirements: protect the slides from light when not in use. Consider storing in the box in which they come, or in the opaque slide storage box (provided).</p>
--	---

6. Marine Life Samples

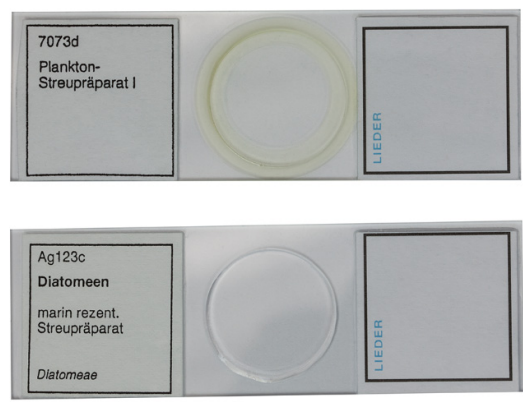
	<p>1) Plankton Slide: Labeled “7073d Plankton - Streupräparat I,” Plankton Strew Slide</p> <p>2) Diatom Slide: Labeled “Ag123c Diatomeenerde”, Diatom Strew Slide</p> <p>No special storage requirements; we suggest storing them in the (provided) slide storage box.</p>
---	--

7. Sample Storage Box

	<p>A sample storage box is provided with the kit. All above samples can be put into one easy accessible place for the students.</p>
---	---

Chapter 7 Software Installation and Digital Materials

7.1 Software Installation

It is important to install the corresponding software before connecting the cameras or spectrometer to the computer. The software is provided on a CD with the devices, however we advise downloading the latest version from the Thorlabs website.

On the computer to be used for the Labs, please install the following software:

7.1.1 ThorCam Camera Software

Download the latest ThorCam Software here:

https://www.thorlabs.com/software_pages/ViewSoftwarePage.cfm?Code=ThorCam

You will be asked about the drivers to be installed. Be sure to enable the installation of the USB drivers during the installation process.

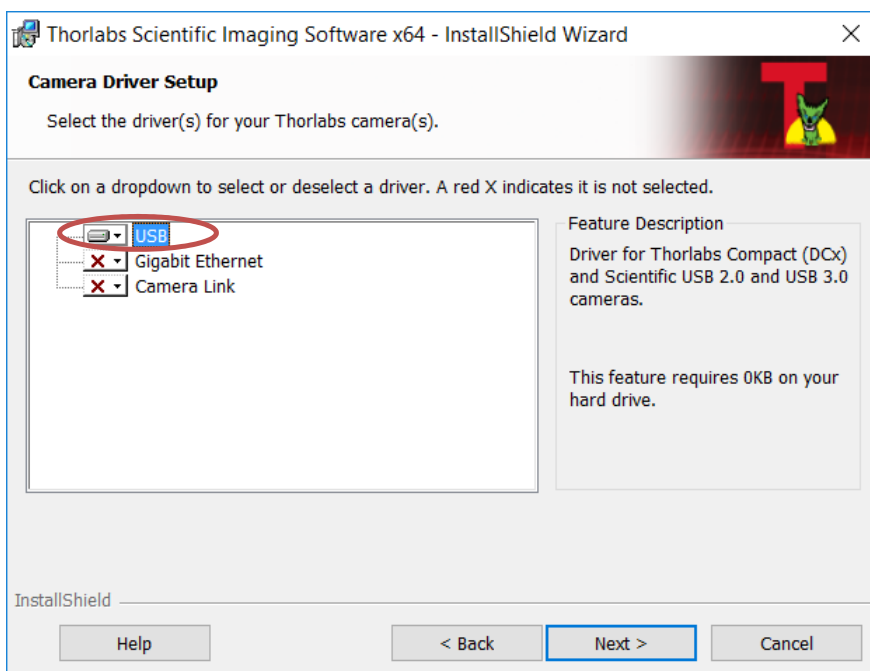

Further information about the software installation and additional information about software operation can be found in the respective manuals.

CCS Spectrometer Installation and Quick Start Manual

CCS Spectrometer Manual

A quick video tour through the settings needed for the kit can be found on the EDU-OMC1(/M) product page on <http://www.thorlabs.com/OMC> website and in the Lab Notes material.

7.1.2 Thorlabs OSA Spectrometer Software

Download the OSA Spectrometer Software for CCS200 (CCS200/M). Use the **Full Installer**: https://www.thorlabs.com/software_pages/ViewSoftwarePage.cfm?Code=OSA

Follow the installations instructions. If you run a 64 bit system you will be asked to install the 32-bit compatible drivers. These are not needed for the kit and you can leave the box unchecked.

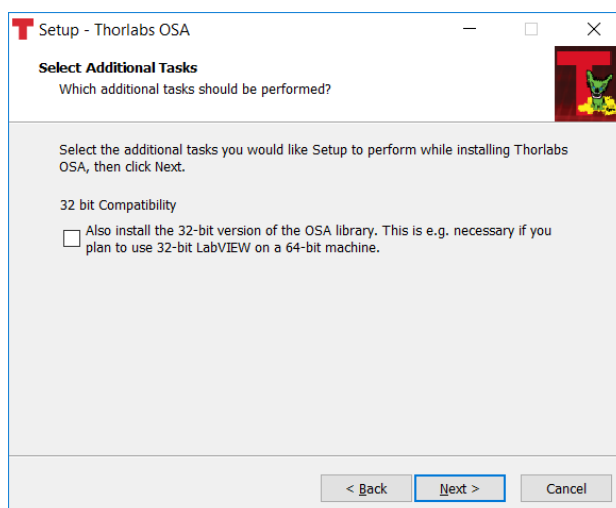

After finalization and a reboot, you can attach the devices via USB to your PC. Wait until the driver installation completes before starting the respective software. The documentation of this kit includes the documentation of all necessary software functions. Further information about the software installation and additional information about software operation can be found in the respective manuals.

DCC Camera Series Quick start guide

DCC Camera Series Software Manual

A quick video tour through the settings needed for the kit can be found on the EDU-OMC1(/M) product page on <http://www.thorlabs.com/OMC> website and in the Lab Notes material.

The students start exploring the camera and spectrometer software and its features during Lab 1, and the features needed for that Lab are covered in the Lab 1 Lab Notes.

➔ **We strongly advise testing the cameras and spectrometer after software installation to make sure the software installation was successful prior to the student labs.**

7.1.3 Additional Software

1. **ImageJ:** The open source image post-processing software from the U.S. National Institutes of Health, NIH ImageJ is used for evaluation of student data; it should be installed. An introduction in the necessary ImageJ functions can be found in Lab 1 Lab Notes.
2. **Text and Data applications:** Desktop shortcuts to a word processor, spreadsheet, and presentation software (e.g. Microsoft Word, Excel, and PowerPoint) can be convenient.

7.2 Supplied Digital Materials

The included USB Stick includes the following material which can also be found on the product website:

- Manual – How to Set Up the Rail and Optical Components
- Lab Notes – Practical Description of the Included Experiments
- Course Notes – Theoretical Background
- Instructor Notes – Tips for Instructors Teaching the Labs



PLEASE: DO NOT copy the entire USB stick onto the student computer(s). If students obtain the Instructor Notes, they will eventually end up on the web, and the quality of the lab experience will be degraded for future students.

- Assembly Videos – These videos will help aligning the complete system in a short way. In contrast to the lab courses, it skips several explanations and is reduced to get the microscope running.
- Peter Evennett's "A Journey through the Microscope" Video – Lecture about optical properties, conjugate planes and resolution in a microscope.

Chapter 8 Regulatory

As required by the WEEE (Waste Electrical and Electronic Equipment Directive) of the European Community and the corresponding national laws, Thorlabs offers all end users in the EC the possibility to return “end of life” units without incurring disposal charges.

- This offer is valid for Thorlabs electrical and electronic equipment:
- Sold after August 13, 2005
- Marked correspondingly with the crossed out “wheelie bin” logo (see right)
- Sold to a company or institute within the EC
- Currently owned by a company or institute within the EC
- Still complete, not disassembled and not contaminated

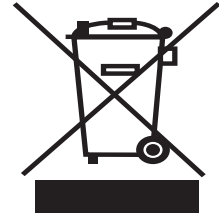

Wheelie Bin Logo

As the WEEE directive applies to self-contained operational electrical and electronic products, this end of life take back service does not refer to other Thorlabs products, such as:

- Pure OEM products, that means assemblies to be built into a unit by the user (e.g. OEM laser driver cards)
- Components
- Mechanics and optics
- Left over parts of units disassembled by the user (PCB's, housings etc.).

If you wish to return a Thorlabs unit for waste recovery, please contact Thorlabs or your nearest dealer for further information.

Waste Treatment is Your Own Responsibility

If you do not return an “end of life” unit to Thorlabs, you must hand it to a company specialized in waste recovery. Do not dispose of the unit in a litter bin or at a public waste disposal site.

Ecological Background

It is well known that WEEE pollutes the environment by releasing toxic products during decomposition. The aim of the European RoHS directive is to reduce the content of toxic substances in electronic products in the future.

The intent of the WEEE directive is to enforce the recycling of WEEE. A controlled recycling of end of life products will thereby avoid negative impacts on the environment.

Chapter 9 Thorlabs Worldwide Contacts

For technical support or sales inquiries, please visit us at www.thorlabs.com/contact for our most up-to-date contact information.



USA, Canada, and South America

Thorlabs, Inc.
sales@thorlabs.com
techsupport@thorlabs.com

Europe

Thorlabs GmbH
europe@thorlabs.com

France

Thorlabs SAS
sales.fr@thorlabs.com

Japan

Thorlabs Japan, Inc.
sales@thorlabs.jp

UK and Ireland

Thorlabs Ltd.
sales.uk@thorlabs.com
techsupport.uk@thorlabs.com

Scandinavia

Thorlabs Sweden AB
scandinavia@thorlabs.com

Brazil

Thorlabs Vendas de Fotônicos Ltda.
brasil@thorlabs.com

China

Thorlabs China
chinasales@thorlabs.com



THORLABS
www.thorlabs.com
